

ITS- MSR-2004035

Description

Weight: 1720 g
Haltekraft: 2300 N

Coil Data

Duty (%)	100	-	-	-
Power Drain (Watt)	13	-	-	-
Max. Duty (Seconds)	∞	-	-	-

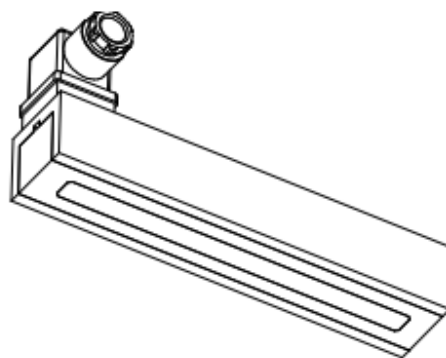

Solenoid Layout

Voltage:
12 VDC (standard)
24 VDC (standard)
other voltages on request

Special development

Sie wollen diesen Standardmagneten abändern (z. B. Abmessungen, Kräfte, usw ...) dann senden Sie uns einfach dieses Formular: [Checkliste \(PDF, 390 kB\)](#)

